

## E-506.10 Charge-controlled amplifier module

Description .....	1
Charge-controlled piezo operation .....	1
Position servo-control operation .....	1
CE conformity .....	2
Safety notes .....	3
Operating controls .....	3
Actuator/stage requirements .....	4
Working principle .....	4
Matching to different capacitive loads .....	5
Gain .....	6
Static (DC) operation ( $f < f_{trans}$ ) .....	6
Dynamic (AC) operation ( $f > f_{trans}$ ) .....	6
Technical data .....	7
Operating limits diagram .....	7
Block diagram .....	8
Specifications .....	9
Pin connections .....	10

### Description

The E-506.10 amplifier module is based on the principle of charge control, i.e. the input voltage controls the amount of charge which is transferred to the piezo actuator. The result is a precise linear displacement of the piezo actuator accompanied by high dynamics.

The typical hysteresis in the piezo displacement, which always occurs when voltage amplifiers are used, is reduced here to only 2% without the need for a position feedback.

The E-506.10 module can output and sink peak currents of 2 A in a voltage range between -30 and 130 V, and is intended for use in the E-500 piezo controller system.

The modular design makes the E-500 system very flexible.

Up to three E-506.10 modules can be installed in an E-500 19" chassis, one in the E-501 9.5" chassis.



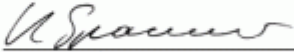
### Charge-controlled piezo operation

In charge-controlled operation (open-loop) the piezo displacement is either precisely adjusted manually with a high-resolution, 10-turn offset potentiometer or controlled via an analog signal. Open-loop operation is ideal for applications where fast response times and very high resolutions at maximum bandwidth are required. The setting or the feedback of the position in absolute terms is then either not important or is performed by an external feedback control system.

### Closed-loop operation

The E-500 / E-501 chassis allows for simple installation of the optional E-509 sensor/ servo controller module for position servo-control operation. Depending on the given target position, the control circuit determines all voltages required. A position accuracy and repeatability in the nanometer range is possible, depending on the piezo mechanics connected and the type of sensor used.

## CE conformity

Piezo · Nano · Positioning 		
<b>Declaration of Conformity</b> according to DIN EN ISO/IEC 17050:2005-01		
<b>Manufacturer:</b>	Physik Instrumente (PI) GmbH & Co. KG	
<b>Manufacturer's Address:</b>	Auf der Römerstrasse 1 D-76228 Karlsruhe, Germany	
<p>The manufacturer hereby declares that the product</p> <p>Product Name: <b>High Linearity Piezo Amplifier Module</b></p> <p>Model Numbers: <b>E-506</b></p> <p>Product Options: <b>all</b></p> <p>complies with the following European directives:</p> <p>2006/95/EC, Low voltage directive (LVD)</p> <p>2004/108/EC, EMC-Directive</p> <p>The applied standards certifying the conformity are listed below.</p> <p><b><u>Electromagnetic Emission:</u></b> EN 61000-6-3, EN 55011</p> <p><b><u>Electromagnetic Immunity:</u></b> EN 61000-6-1</p> <p><b><u>Safety (Low Voltage Directive):</u></b> EN 61010-1</p> <p>Electrical equipment which is intended to be integrated in other electrical equipment only conforms to the cited EMC Standards and normative documents, if the user ensures a compliant connection when implementing the total system. Possible necessary measures are installation of the component in a suitable shielded enclosure and usage of suitable connectors.</p> <p>23 February 2010          Karlsruhe, Germany</p> <div style="text-align: center;">           Dr. Karl Spanner          President       </div>		
<p style="font-size: small;"> <a href="http://www.pi.ws">www.pi.ws</a> Physik Instrumente (PI) GmbH &amp; Co. KG · Auf der Römerstr. 1 · 76228 Karlsruhe, Germany          Phone +49 721 48 46-0 · Fax +49 721 48 46-299 · E-mail info@pi.ws       </p>		

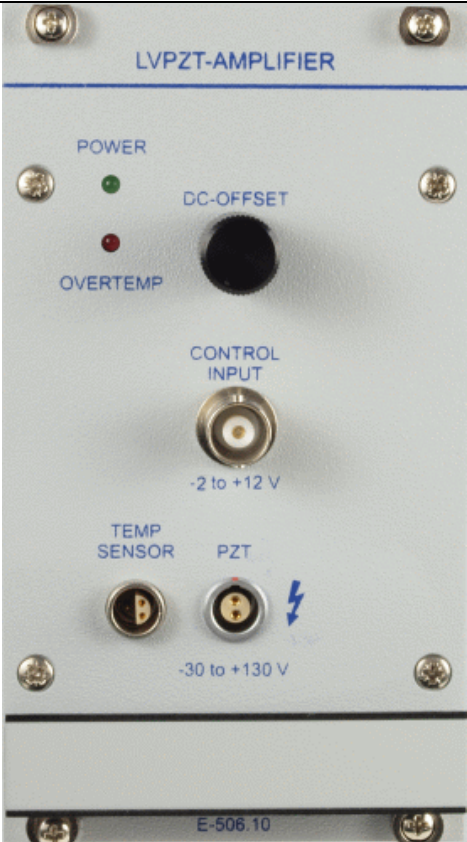
## Safety notes

### Danger - high voltage

E-506.10 charge amplifiers supply VERY HIGH VOLTAGES and HIGH CURRENTS which can result in death or serious injuries! Only suitably qualified personnel must be allowed to work with these instruments. Adhere to the accident prevention guidelines!

- Do not touch any pins of the “PZT” LEMO socket. When the controller is switched on, the amplifier output can carry high voltage at any time. There can be voltages of between -30 V and + 130 V on the LEMO socket.
- Ensure that the A-32 and C-32 pins are connected to the protective earth conductor (when supplied without housing)!
- Neither actuator housing nor piezo stage housing and actuator return conductor must be short circuited. If they are, the amplifier may output the maximum voltage despite 0 V control signal.

## Operating controls

 <p>LVPZT-AMPLIFIER</p> <p>POWER (green LED)</p> <p>DC-OFFSET (knob)</p> <p>OVERTEMP (red LED)</p> <p>CONTROL INPUT (BNC socket)</p> <p>-2 to +12 V</p> <p>TEMP SENSOR (BNC socket)</p> <p>PZT (LEMO socket)</p> <p>-30 to +130 V</p> <p>E-506.10</p>	“DC-OFFSET” knob	10-turn potentiometer for DC offset adjustment
	“CONTROL INPUT” BNC socket	Connection of control signal
	“PZT” LEMO socket 2 pins.	High voltage output to piezo actuator  The actual maximum possible voltage depends on the supply voltage provided for the amplifier module.
	“TEMP SENSOR” LEMO socket 3 pins.	Connection for temperature sensor PT1000, or dummy plug.  Deactivates PZT voltage output if a piezo temperature of 150°C is exceeded. Automatic reactivation at a piezo temperature < 146 °C
	“POWER” LED	Permanent green light when in operation
	“OVERTEMP” LED	Permanent red light when temperature threshold is exceeded at piezo actuator

## Actuator/stage requirements

The underlying amplifier principle requires the following for the piezo actuator or the piezo stage:

- Floating ground construction: It is important that housing and actuator return conductor must not be short circuited! If they are, the amplifier may output the maximum voltage on the "PZT" LEMO socket despite 0 V control signal.
- Capacitance of the piezo actuator is at least 0.3  $\mu\text{F}$
- 2 pin LEMO socket
- Note: Standard nanopositioning stages are not suitable for operation with the E-506.10 and cannot be connected via an adapter!

## Working principle

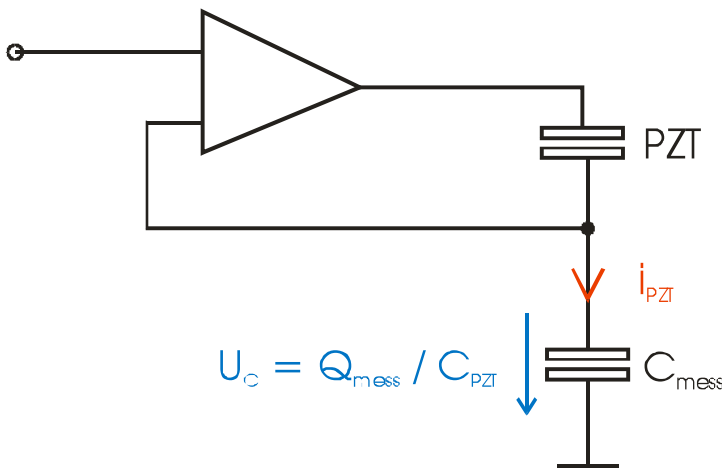


Fig. 1: Schematic circuit diagram of a charge-controlled piezo amplifier

$$Q = C_{\text{PZT}} * U_{\text{PZT}} = C_{\text{mess}} * U_{\text{C}}$$

Equ. 1: Relationship between the capacitances ( $C_{\text{PZT}}$  = piezo actuator,  $C_{\text{mess}}$  = reference capacitance in the electronics), the voltage applied and the charge deposited

- The input voltage (CONTROL INPUT) controls the charge  $Q$  which is transferred to the piezo actuator (during the charging time).
- The actuator displacement is proportional to the amount of charge applied (linear relationship)
- In the series circuit the charge on every  $C$  is constant. If the largest portion of the voltage must actually arrive at the piezo actuator,  $U_{\text{C}}$  must be small compared to  $U_{\text{PZT}}$ ,  $C_{\text{mess}}$  must therefore be large compared to  $C_{\text{PZT}}$ . This means that the size of the reference capacitance  $C_{\text{mess}}$  in the electronics must be individually matched to the piezo actuator and its electrical capacitance.
- The charge control has a lower transition frequency below which it functions as a voltage-controlled amplifier (see Table p. 9).
- An additional voltage stabilization maintains the DC operating point.

### **Matching to different capacitive loads**

In order to be able to use the function of the piezo amplifier to optimum effect, the device must be matched to the electrical capacitance of the piezo actuator. If a system comprising an actuator and electronics has been purchased, PI provides this matching.

The reference capacitance  $C_{\text{mess}}$  should amount to 20 times the value of the small-signal capacitance of the piezo actuator.

The reference capacitance can also be adjusted by the customer. This is done as follows:

- Remove the back panel of the amplifier module (4 screws)
- Remove the side panel of the amplifier module (2 screws on the front of the device)
- The reference capacitance is adjusted by setting the jumpers 1 to 8 (see Fig. and Table below). The reference capacitance desired is achieved by adding the jumper capacitance values set.

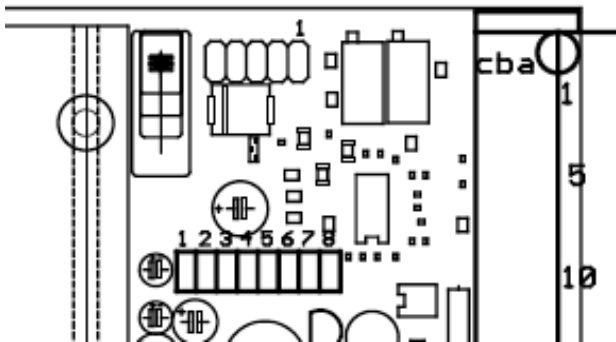


Fig. 2: Jumper E-506.10

Capacitance values of the jumpers

Jumper 1	1 µF
Jumper 2	2.2 µF
Jumper 3	4.7 µF
Jumper 4	10 µF
Jumper 5	10 µF
Jumper 6	47 µF
Jumper 7	100 µF
Jumper 8	100 µF

### **Basic setting when supplied**

Unless specified otherwise, the basic setting of the reference capacitance is 200 µF.

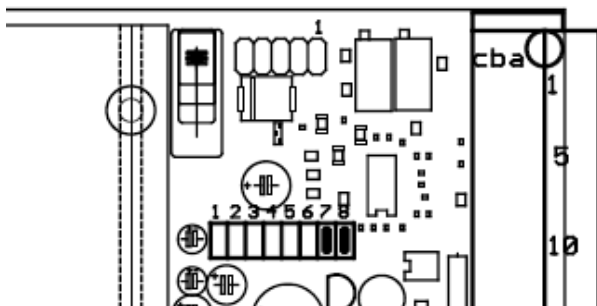


Fig. 3: Jumper E-506.10 for 200 µF reference capacitance

## Gain

If the frequency falls below a transition frequency, which depends on the electrical capacitance, the amplifier changes into the familiar voltage-controlled operation. In this case the displacement is again subject to hysteresis, i.e. for a constant voltage the actuator displacement drifts by a few percent (up to the value of the piezo hysteresis at this operating point). This also applies if the offset potentiometer is used to set a DC voltage for the selection of the DC operating point. The corresponding piezo displacement is subject to the normal hysteresis of around 10%. The worse the matching of the reference capacitance to the actuator capacitance, the stronger is this effect.

**It is thus recommended that the customer states the actuator value when placing the order and lets PI perform the matching!**

A position feedback is recommended for positioning tasks.

Transition frequency  $f_{\text{trans}}$ : see Table "Minimum frequencies for charge-controlled operation", technical data\specifications (p. 9)

### Static (DC) operation ( $f < f_{\text{trans}}$ )

In this frequency range the amplifier works in voltage-controlled operation. The input control signal (CONTROL INPUT) has a gain of 10.

### Dynamic (AC) operation ( $f > f_{\text{trans}}$ )

In this frequency range the amplifier works in charge-controlled operation. The associated gain depends on the control frequency, the signal amplitude, and in addition also on the piezo temperature. For stable operation it is recommended that the frequency and amplitude bands used are as narrow as possible.

The aim is to adjust the gain in charge-controlled operation to the same value as for voltage-controlled (DC) operation, i.e. factor of 10. This avoids deviations in the piezo displacement. This requires that the internal reference capacitance must be adjusted to the actuator capacitance.

Note: Unless stated otherwise, all information on the actuator capacitance refers to the small-signal capacitance and thus corresponds to the values given in the PI catalog.

Basic equation:  $Q_{\text{out}}[\text{As}] = U_{\text{in}}[\text{V}] * C_{\text{mess}} = U_{\text{in}}[\text{V}] * 20 * C_{\text{aktor}} [\text{As/V}]$

where:  $C_{\text{mess}} \sim 20 * C_{\text{aktor}}$  (small-signal capacitance) or  
 $C_{\text{mess}} \sim 10 * C_{\text{aktor}}$  (large-signal capacitance)

and:  $U_{\text{out}} = Q_{\text{out}} / C_{\text{aktor}} \text{ (large)} = U_{\text{in}} * C_{\text{mess}} / C_{\text{aktor}} \text{ (large)}$

$U_{\text{out}}$ : Voltage at the piezo output of the amplifier

$Q_{\text{out}}$ : Charge deposited at the piezo actuator

$U_{\text{in}}$ : Control signal input (CONTROL INPUT)

$C_{\text{mess}}$ : Reference capacitance

$C_{\text{aktor}}$ : Small-signal capacitance of the piezo actuator

The AC gain in [As/V] is equal to  $C_{\text{mess}}$ .

**Example:**

With  $U_{in} = 10 \text{ V}$  and  $C_{aktor} = 10 \text{ }\mu\text{F}$  the result is:  $Q_{out} = 10 \text{ V} \cdot 200 \text{ }\mu\text{As/V} = 2,000 \text{ }\mu\text{As}$

For an actuator with  $10 \text{ }\mu\text{F}$  small-signal capacitance or  $20 \text{ }\mu\text{F}$  large-signal capacitance this charge corresponds to a voltage of around  $2,000 \text{ }\mu\text{As} : 20 \text{ }\mu\text{As/V} = 100 \text{ V}$

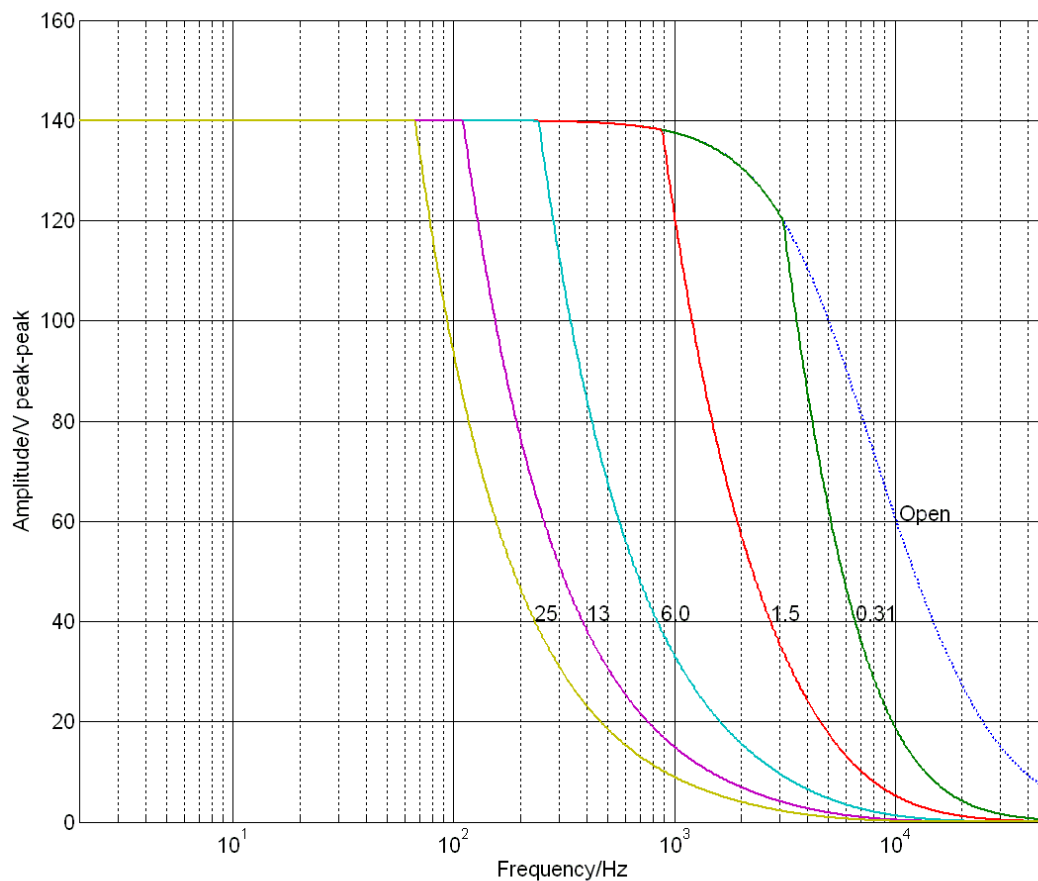
**Technical data****Operating limits diagram**

Fig. 4: Operating limits (open-loop) with different piezo loads, capacitance values in  $\mu\text{F}$ . The minimum capacitive load is 0.3  $\mu\text{F}$

## Block diagram

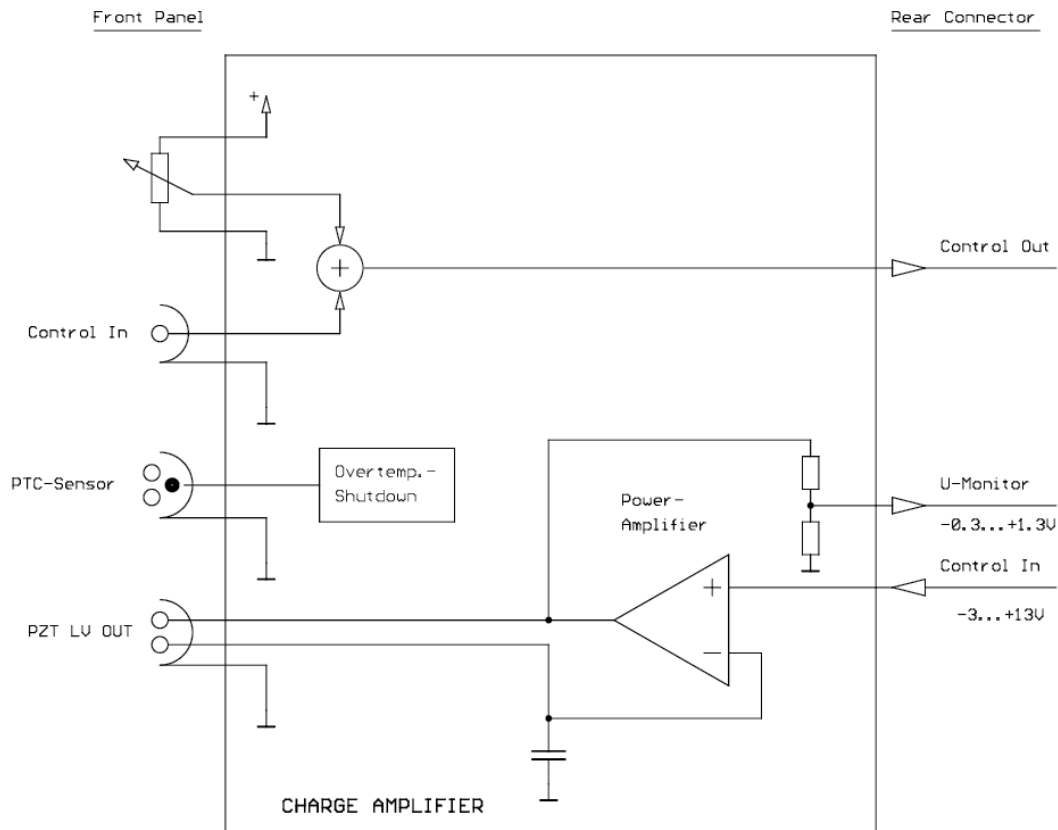


Fig. 5: E-506.10 circuit. The recommended range for the input control signal (CONTROL INPUT) is -2 to +12 V. -3 to +13 V are possible, resulting in a piezo voltage of -30 to +130 V. The recommended operating voltage for multilayer piezo actuators is -20 to +120 V. Increased operating voltages can result in a shorter life span.



## Specifications

	<b>E-506.10</b>	
Function	Linearized amplifier, charge controlled	
Channels	1	
<b>Amplifier</b>		
Input voltage range	-2 to +12 V	
Output voltage*	-30 to 130 V	
Peak power (<2.5 ms)	280 W	max.
Average output power	30 W	max.
Peak current (<2.5 ms)	2 A	
Average output current	215 mA	
Current limitation	short-circuit proof	
Noise	<0.6 mVrms	
Reference capacitance (adjustable)	1 to 280 $\mu$ F	
Input impedance	1 M $\Omega$ / 1 nF	
<b>Interfaces and operation</b>		
Piezo connection (voltage socket)	LEMO 2 pin, EGG.0B.302.CLL	
Analog input / control input socket	BNC	
DC offset adjustment	10-turn potentiometer, adds 0 to 10 V to input voltage	
Piezo temperature sensor (input)	PT 1000; LEMO socket, automatic high voltage deactivation at 150 °C	
<b>Environment</b>		
Operating temperature range	+5 to +50 °C	
Dimensions	14HP/3U	
Mass	0.9 kg	
Operating voltage	E-500 system	
Power consumption	55 W	max.

\*deactivation of the voltage output at max. 85 °C internal (overheating protection)

Minimum frequencies\* for charge-controlled operation:

<b>Actuator capacitance</b>	<b><math>f_{trans}</math></b>
0.33 $\mu$ F	250 mHz
1.06 $\mu$ F	80 mHz
6.2 $\mu$ F	9 mHz
14 $\mu$ F	4 mHz

\* Voltage-controlled operation for lower frequencies

## Pin assignments

### PZT High Voltage

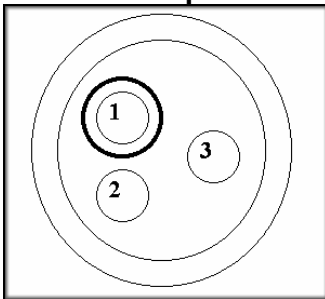


Top pin: Plus

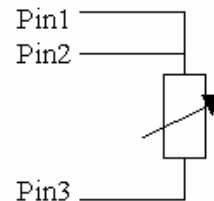
Bottom pin: Return conductor (minus; the actuator connected must have a floating-ground construction!)

Housing: Protective earth

### PT1000 Temperature sensor



LEMO EPL.OS.303.HLN Temperature sensor socket



Schematic circuit diagram of temperature sensor

Pin 1: Temp\_SA

Pin 2: Temp\_S

Pin 3: GND/PE

Housing: Protective earth conductor/GND/PE

### E-506.10 Pin connections (32 pin connector, DIN 41612, male)

Row	PIN a	PIN c
2	Power Fail	OUT: ch1 (BNC+Bias)
4	IN: ch1	OUT: ch1 (monitor)
6	PZT GND	PZT GND
8	OUT: PZT	OUT: PZT
10	n.c.	n.c.
12	n.c.	n.c.
14	n.c.	n.c.
16	IN: -15 V	n.c.
18	n.c.	n.c.
20	n.c.	n.c.
22	GND (measurement)	GND (measurement)
24	GND (power)	GND (power)
26	IN:+27 V	IN: +27 V
28	IN: -37 V	OUT: -10 V
30	IN: +137 V	IN: +137 V
32	Protective earth (chassis)	Protective earth (chassis)

Note:

If the module is operated outside the E-500 system, pins 2c and 4a must be connected with each other.